

X11/X11C **GYROSCOPE 2.4G** **EXPLORERS**

4CH 2.4G REMOTE CONTROL QUADCOPTER

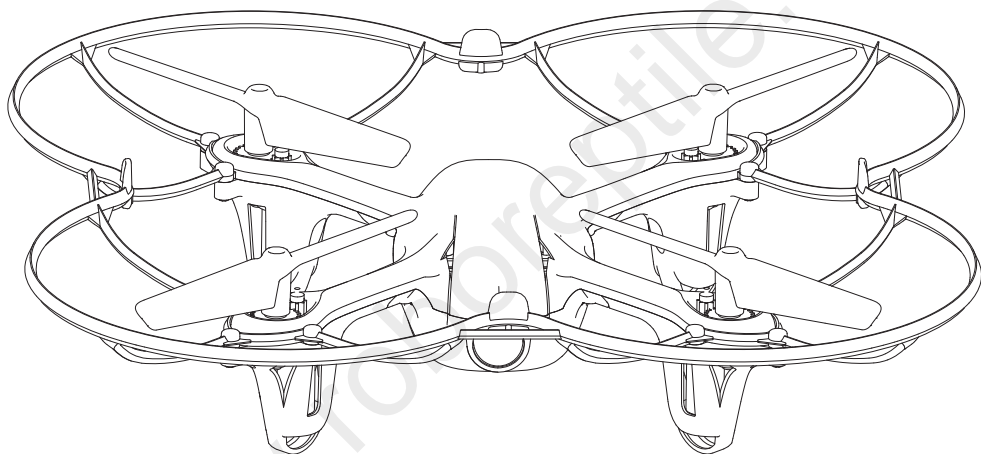

1

INSTRUCTION MANUAL

IMPLEMENT STANDARD: GB/T26701-2011

Main characteristics

- Four-axis structure is applied, which makes the quadcopter more flexible and rapid when flying. It has the characteristics of wind-resistant and can be flown indoor or outdoor.
- Built-in 6 axis gyroscope for precise hovering in the sky.
- Modular design structure is applied, more simple for assembly and convenient for maintenance.
- With 360°3D eversion function and throwing flight function .

The materials and specification mentioned in this instruction manual or the parts inside this package is for reference only. Our company won't be responsible for any adaptation of the outer package. Nor shall we keep our customers informed in advance. Any information updates or changes, please be subject to our website .

PREFACE

Dear customers:

Hello!

Thank you for purchasing our flying model. Please read this instruction manual carefully in order to master the skill required quickly and operate this product more safely. In the mean time, please well keep the original of this instruction manual for future reference.

IMPORTANT INSTRUCTION

1. This product is not a toy but one precise equipment that integrating mechanics and electronics with expertise of aerodynamics and high-frequency transmitting. It requires to be correctly assembled and debugged so as to prevent the accident from being happened. The product owner should operate or control it in safe way. Please noted that we won't take any responsibility for any wrong operation as this may result in severe injury or loss of property and we can not control the operating process during the time when the user assemble or use this product.
2. This product is suitable to be used by people who has operating experience in flying model or age no less than 14 years old.
3. The flying ground we required should be the local field and legal for remote control flying.
4. Once this product is sold , we won't be responsible for any safety responsibility during the time the user operates or uses or controls this product.
5. If there is any problem occurred during the time of using, operating or repairing, please reach our sales agent for details. The sales agent that we authorized will provide you with the technical support and after-sale service.

SAFTY & CAUTIONS

This R/C flying model is a high dangerous commodity. Please make sure that it should be flied far away from the crowd. Please also pay more attention to the phenomenon such as incorrect assembly or damaged model or incorrect connection of electronic control equipment. Please also pay attention to the flying safety when operating and know more about the accident that may be happened due to your own negligence.

1. Keep it far away from the barrier or crowd.
2. Keep it far away from the moisten environment.
3. Use this product correctly and avoid operating by your own.
4. Keep it far away from the high-speed rotating part and heat source.
5. Please conform to the sequence of power ON/OFF. As the picture below shown, incorrect sequence of power ON/OFF may cause this product out of control and affect your own safety or others. Please form a good habit of switching on or switching off this product correctly.

ABOUT CONTENTS

Product included following contents:

- Quadcopter
- 2.4G Remote controller
- USB charging wire
- Instruction manual
- Reader
- Blade(4 pieces)

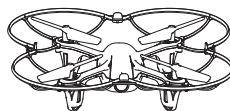

GET TO KNOW YOUR TRANSMITTER

Introduction of transmitter

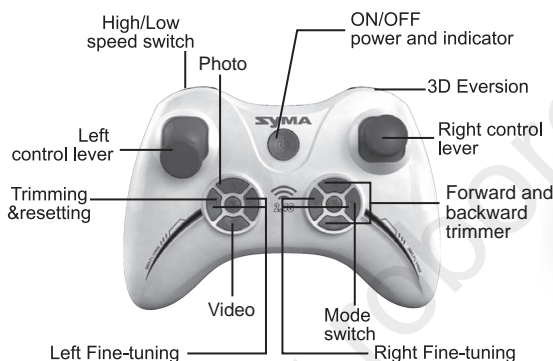

Remote control Installing the battery

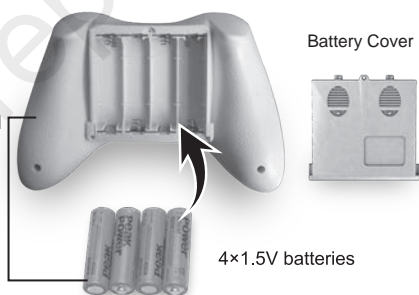

Open the back cover at the back of the transmitter. Load 4PCS “AA” alkaline batteries correctly into the battery compartment as per the correct polarity shown on the battery compartment.

READY TO FLY YOUR QUAD COPTER



Step 1: First of all, press the ON/OFF power switch.

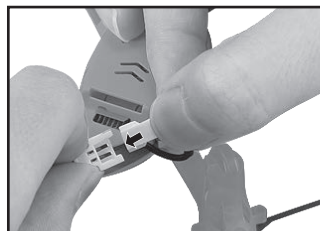

Step 2: Insert the power line into the quad copter and place it on the level ground.

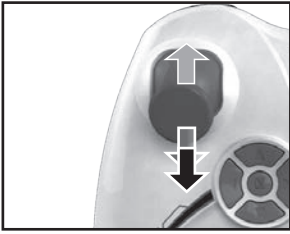

Step 3: Push the throttle lever to the highest position and then pull it back to the lowest position, this time there will be one clear sound sending out from the transmitter, this shows that the quad copter has entered into the pre-fly state.

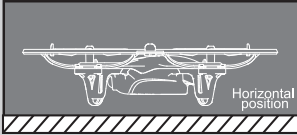

TIPS: When matching signal, keep the quad copter on horizontal position to fast matching and start a stable flight.

CAUTIONS:

1. When the indicator of the transmitter appears eternal bright, however, the indicator of the quadcopter appears slow flashing, this means that decoding is not successful. This time please disconnect the power both of the quad copter and transmitter, then repeat the pre-flying steps.
2. If the quadcopter is tilting to one side abruptly or spinning while hovering, please switch off the power both of the quad copter and transmitter and then repeat the pre-flying steps.
3. When the indicator of the quad copter keeps flashing slowly, it means that the quad copter has entered into the low voltage protection state. This time you need to charge the quadcopter.

FUNCTIONS MODE SWITCH, FINE-TUNING RESET AND LEVEL CALIBRATION



Mode switch function:
Keep pressing the button A, then switch on the power of the transmitter, you can select Mode 1 or Mode 2.



Resetting function :
Keep pressing the button B, then switch on the power of the transmitter. Enter into the Trimming & Resetting Mode (It is highly suggested that the freshman should reset the trimmer first before starting the first flight.)



Level calibration function:
If quad-copter always fly to a side when starting, please re-match signal and place it on a horizontal plane. Then turn the two levers to the lower right corner (as left image) for seconds, when indicator keep light up, it finishes auto level calibration.

ILLUSTRATION ON CONTROLLING THE QUAD COPTER (MODE 1, DEFAULTED MODE WHEN STARTING)

Operating direction

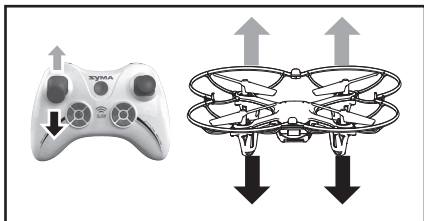

Push the throttle up or down, the quadcopter flies upward or downward.

MODE1

Fine-tuning operation

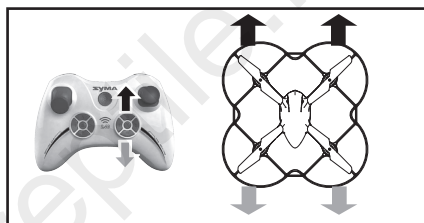

When the quad copter keeps flying forward / backward, you can correct it by pressing under / top fine-tuning button.

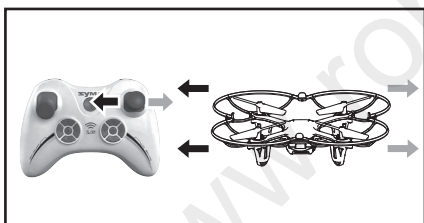

Pull the direction lever left or right, the quadcopter flies to left side or right side.

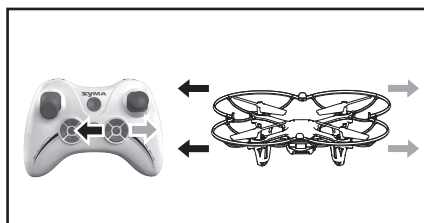

When the quad copter keeps flying to left / right side, you can correct it by pressing the right / left fine-tuning button.

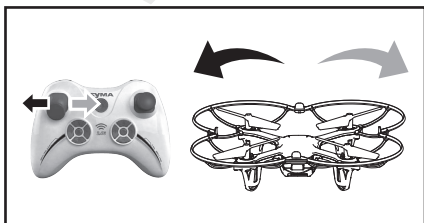

Pull the throttle left or right, the quadcopter turns to left or right.

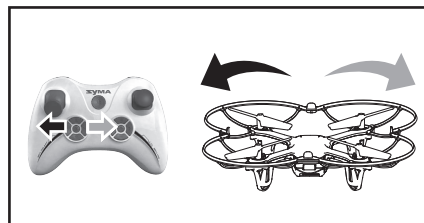

When the quad copter keeps rotating to left / right, you can correct it by pressing the left / right fine-tuning button.

ILLUSTRATION ON HOW TO CONTROL THE QUAD COPTER (MODE 2)

Operating direction

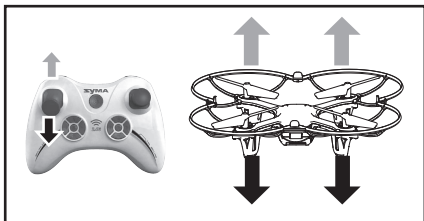

Push the throttle up or down, the quadcopter flies upward or downward.

MODE2

Fine-tuning operation

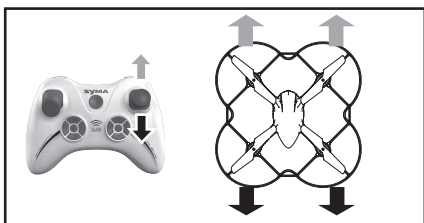

Push the direction lever up or down, the quadcopter flies forward or backward.

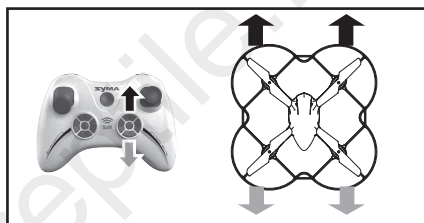

When the quad copter keeps flying forward / backward, you can correct it by pressing under / top fine-tuning button.

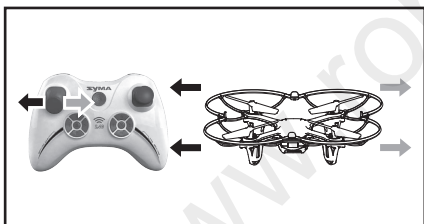

Pull the direction lever left or right, the quadcopter flies to left side or right side.

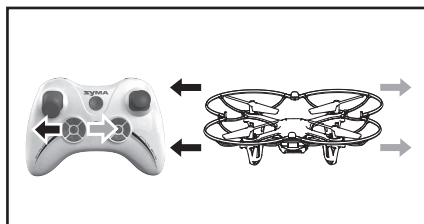

When the quad copter keeps flying to left / right side, you can correct it by pressing the right / left fine-tuning button.

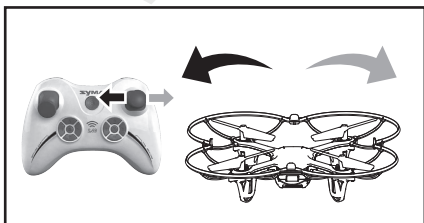

Pull the throttle left or right, the quadcopter turns to left or right.

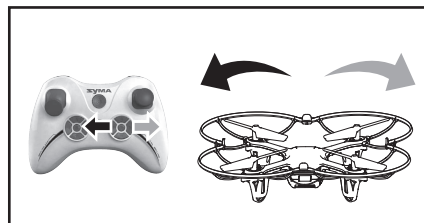

When the quad copter keeps rotating to left / right, you can correct it by pressing the left / right fine-tuning button.

FLIGHT CONTROL

Low Speed: Press the High/Low speed switch for one time, the buzz will send out one sound.

High Speed: Please press High/Low speed switch once again, the buzz will send out two sounds.



3D EVERSION AND THROWING FLIGHT INSTRUCTIONS

1. When you are familiar with the basic operation, you can play some awesome & thrilling stunt operation. First of all, fly the four-axial aircraft to the height of more than 3 meters, press the 3D Eversion switch on the right above of the transmitter, then push the right rudder (in any direction) and then you can make 360 degree 3D tumbling operation in any direction and make successive tumbling stunt performance as well.

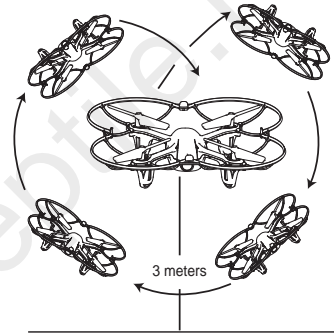

2. Using 6 axis gyroscope, quad-copter bring you more fun. Throw out the quad-copter or push up throttle lever when it rolling, the quad-copter could hover smoothly in the sky.



BATTERY CHARGING

Battery charging

Take out the USB charging wire, connect one end to the quad copter, then insert the USB port of the USB charging wire to the USB port of the computer (or the USB port of the power adapter) to charge the battery. During the time of charging, the red indicator of the USB will be ON.

When it is fully charged, the red indicator will be OFF.

Caution:

1. When using the computer for charging, please remember to pull out the charging line before shutting down the computer.
2. Please pay attention to aim correctly to the correct polarity when connecting the USB wire with the battery. Please make sure the polarity should not be upside down.

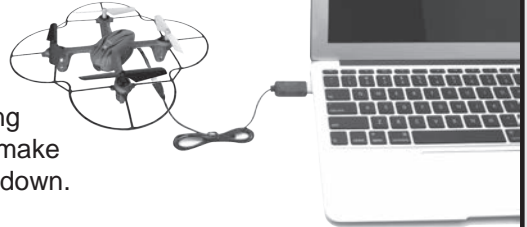

Charging time: about 70 minutes ; Flying time: about 5 minutes

CAUTIONS WHEN CHARGING

1. When charging, please put this product on the dried or ventilated area and keep it far away from heat source or explosive product.
2. When charging, please remove the batteries from the quad copter. All the charging process should be under the guidance of the adult so as not to cause accident.
3. When finish flying, please do not charge the battery which surface temperature is still not cooled down. Otherwise it may cause swollen battery or even cause fire disaster.
4. During the process of battery charging, falling down or striking by the outer force should be avoided. Otherwise it may cause short-circuited within the battery and thus may cause danger.
5. In order to make sure safety, please make sure that you need to use the original USB charging wire that made from our factory. When the battery is used for a long time or appears aging or swollen, please replace them timely.
6. When the batteries are fully charged, if you do not remove it from the charger for a long time, the battery may discharge automatically, which may cause battery exhaustion. When the battery voltage that the charger has tested is lower than the rated voltage, the charger will re-charge the battery until it is fully charged. Charging or discharging too often or repeated charging or discharging may reduce the using life of the batteries.

BATTERY REPAIR & MAINTENANCE

1. Battery should be put in the dried or ventilated place with environment temperature about 18-25 °C.
2. In order to enhance the using life of the battery, please avoid repeat charging or excessive discharging.
3. When the battery needs to be stored for a long time, please charge the battery first. That is to say, charge the battery for about 50-60% of the volume and then well store it.
4. If you do not use it for more than 1 months, it's highly recommended that you need to check the battery voltage every month so as to make sure the voltage no less than 3V. Otherwise please do by following No.(3) mentioned.

PHOTOGRAPHY / VIDEO INSTRUCTIONS:

1. Methods: Turn the quadcopter power on, the camera works normally when the RED indicator change from flashing to green and keep light on. If the RED indicator just light on and light off seconds later, it means the SD card is not in the camera. Please insert the SD card, than the indicator light on GREEN.

2. Get to know take photo and video:

① Turn on the transmitter and pull left lever up and down to connect signal between quadcopter and transmitter.

② Take Photo : Make sure camera normally work, when push the button "C" up, camera will take a photo after a beep from transmitter and the GREEN indicator on camera will be RED and flash on time.

Take Video : Make sure camera normally work , when pull the button "C" down, camera starts to take video after a beep from transmitter and the GREEN indicator on camera will change to RED than keep flashing. Press the button "C" slightly again , another beep from transmitter means video stopped and the RED flashing light on camera will be GREEN and keep light on.



TROUBLE SHOOTING

Symptom	Reason	Troubleshooting
No response from the aircraft	1. Matching frequency is not successfully made. 2. Insufficient power with the aircraft or transmitter.	1. Re-Matching: First of all, switch on the power of the transmitter, then switch on the power of the aircraft and place it on the level ground, finally pushing the throttle lever to the highest and then pull it back to the starting position. 2. Replace the battery of the transmitter or charge the aircraft.
The reaction of aircraft is not smart or intermitting signal.	1. Insufficient power with the transmitter. 2. Antenna of the aircraft is snapped off.	1. Replace the batteries inside the transmitter. 2. Re-welding the antenna.
The aircraft can not make hovering or tilt flying to one side.	1. The aircraft is not placed on the level ground when Matching frequency. 2. The trimmer key on the transmitter is not reset.	1. Re-Matching frequency. 2. Reset the trimmer key on the transmitter, details please kindly check Page3 Functional Adjusting of Flying Resetting. 3. Level calibration

X11A PARTS (OPTIONAL)

Below are the parts available for your kindly selection. In order to facilitate our customers for placing an order, we specially offer all kinds of parts for your kindly selection. You can buy these parts via our local agent as well.

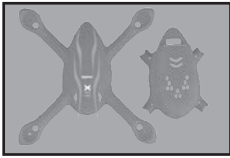

X11-01A
Fuselage-red

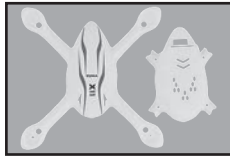

X11-01B
Fuselage-white

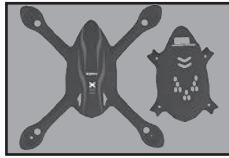

X11-01C
Fuselage-black

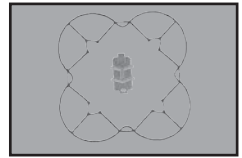

X11-02
Protecting frames



X11A-03
Blades

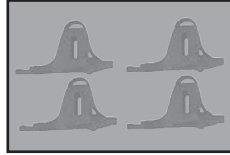

X11-04
Motor holder

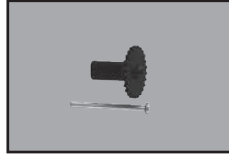

X11-05
Gear

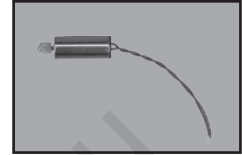

X11-06
Motor A

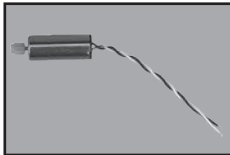

X11-07
Motor B



X11-08
Battery

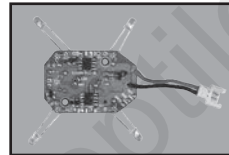

X11-09
Circuit board

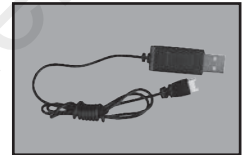

X11-10
USB



X11-11
Transmitter

X11C PARTS (OPTIONAL)

Below are the parts available for your kindly selection. In order to facilitate our customers for placing an order, we specially offer all kinds of parts for your kindly selection. You can buy these parts via our local agent as well.

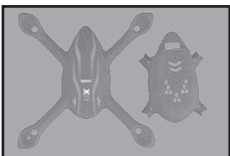

X11C-01A
Fuselage-red

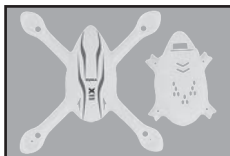

X11C-01B
Fuselage-white

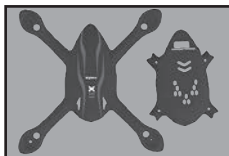

X11C-01C
Fuselage-black

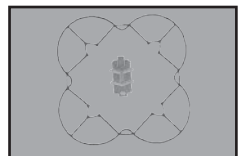

X11C-02
Protecting frames



X11C-03
Blades

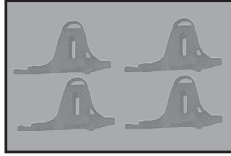

X11C-04
Motor holder

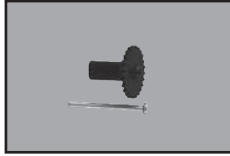

X11C-05
Gear

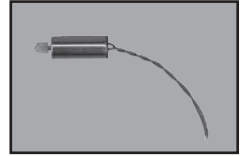

X11C-06
Motor A

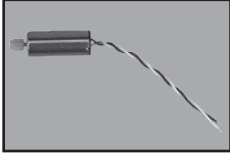

X11C-07
Motor B



X11C-08
Battery

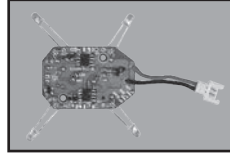

X11C-09
Circuit board

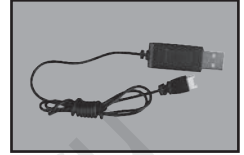

X11C-10
USB

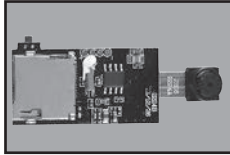

X11C-11
Camera PCB box



X11C-12
Reader



X11C-13
Transmitter

BREAKDOWN & DIAGRAM

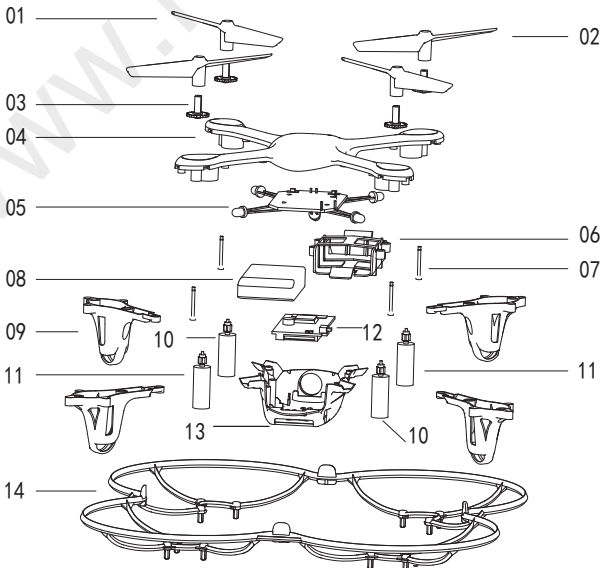

Code	Description	Quantity	Code	Description	Quantity	Code	Description	Quantity
01	Rotating blade	2	07	Metal shafter	4	13	Lower body	1
02	Reversing blade	2	08	Battery	1	14	Protecting frames	1
03	Gear	4	09	Motor holder	4			
04	Upper body	1	10	Rotating motor	2			
05	Circuit board	1	11	Reversing motor	2			
06	Battery case	1	12	Camera PCB box	1			

MAIN PARAMETER

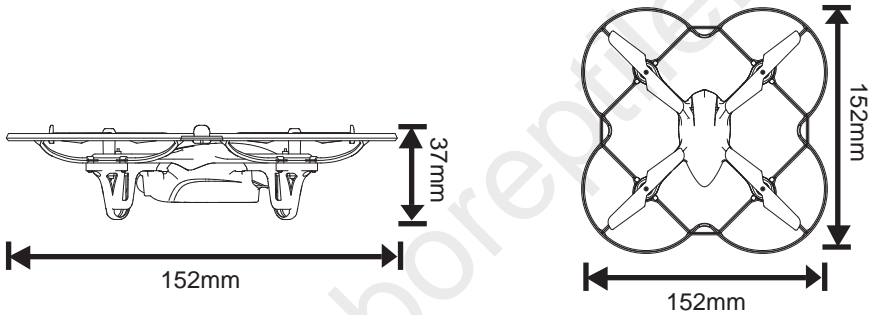

Length of fuselage: 152mm Width of fuselage: 152mm
 Height of fuselage: 37mm Battery: 3. 7V/200mAh
 Code of main engine: 6X15 coreless motor



SPECIFICATIONS AND COLORS OF CONTENTS MAY VARY FROM PHOTO.

The company has the right of final interpretation of this instruction manual statement.